

PER L'ESECUZIONE DI FORI DI MEDIE E GRANDI DIMENSIONI NEL MURO.

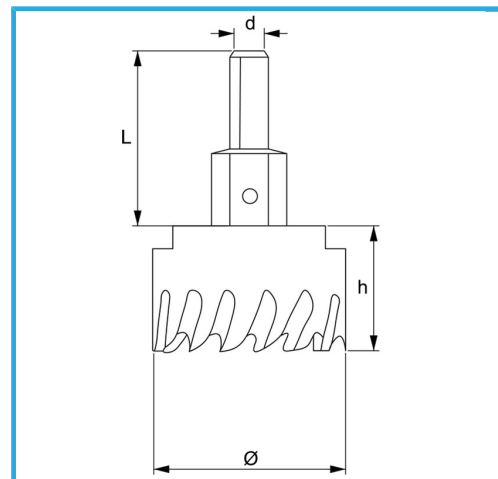

€87,90



Ø	100 mm
d	12 mm
Filetto	M16 x 1,5
Z	11
L	46 mm
Punta	Ø 8 x 69 mm
Peso lordo	0,71 kg
Dimensioni imballo	110x45x130 h mm
Codice EAN	8012667352752



Append.

HSS

HM