

DIN 69871/A, CORPO MANDRINO BILANCIATO, PER FRESE (WELDON)  
SECONDO NORMA DIN 1835 B E DIN 6535 HB. FORNITO CON VITE DI...

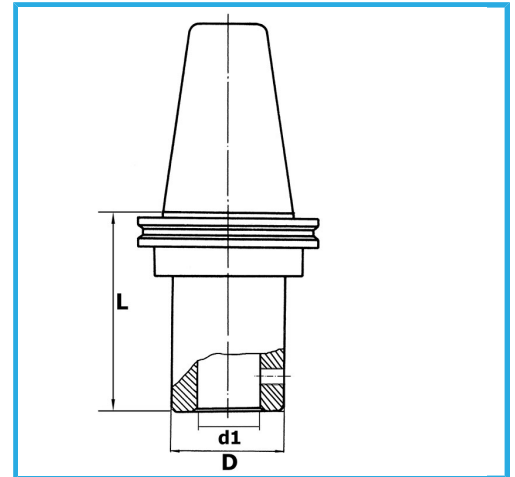

€133,00



|            |               |
|------------|---------------|
| ISO        | 50            |
| d1 - h6    | 6 mm          |
| D          | 25 mm         |
| L          | 65 mm         |
| Peso lordo | 2,82 kg       |
| Codice EAN | 8012667193034 |



Scatola



Rettificato

18Ni  
CrMo5