

ART. M001/05TICN

MASCHIA MACCHINA PER FORI PASSANTI, IMBOCCO
CORRETTO

FERVI

FILETTATURA METRICA A PASSO GROSSO (MA) CON GAMBO
RINFORZATO: IL RIVESTIMENTO IN CARBONITRURO DI TITANIO
COMBINATO...



€12,00

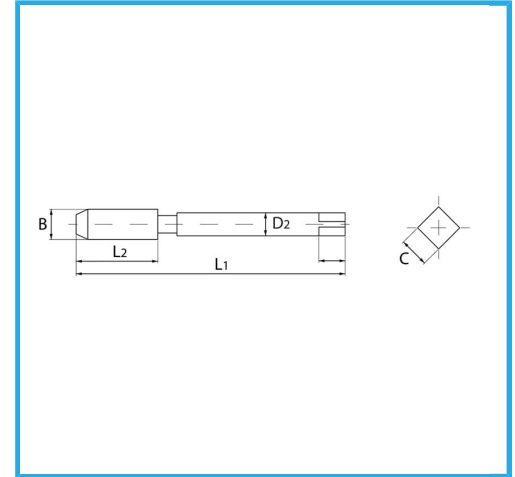
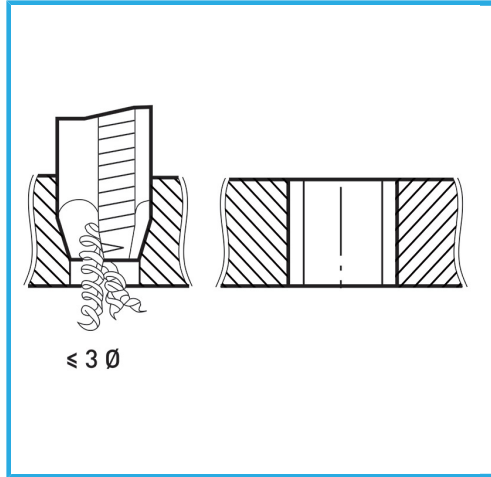

B	M5 x 0,80 mm
L2	16 mm
L1	70 mm
D2	6 mm
C	4,9 mm
Peso lordo	0,03 kg
Codice EAN	8012667417048



Scatola



Esterna