

ISO 2.

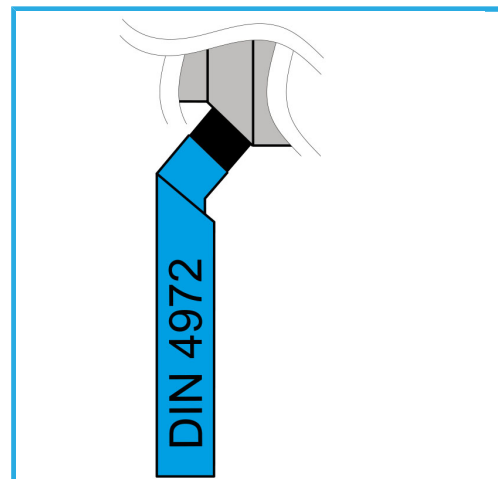

€10,70

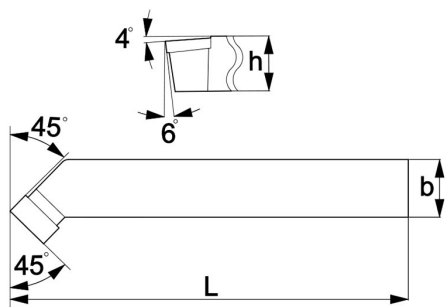

Lato	Dx/R
L	125 mm
b	20 mm
h	20 mm
Dimensioni imballo	160x50x20 h mm
Peso lordo	0,37 kg
Codice EAN	8012667007508

HM
P25



4972