

DIN 2080, CORPO MANDRINO BILANCIATO, PER FRESE (WELDON)  
SECONDO NORMA DIN 1835 B E DIN 6535 HB. FORNITO CON VITE DI  
SERRAGGIO....

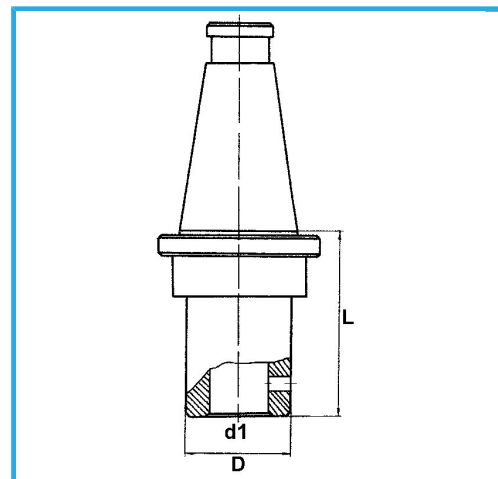

€129,00



ISO	40
d1 - h6	20 mm
D	52 mm
L	63 mm
Peso lordo	1,44 kg
Codice EAN	8012667195991



Scatola



Rettificato

18Ni  
CrMo5