

DIN 228/A PER FRESE CILINDRICHE FRONTALI SECONDO NORMA DIN 481, PER FRESE CON SCANALATURA LONGITUDINALE DIN 1880 E PER FRESE AD...

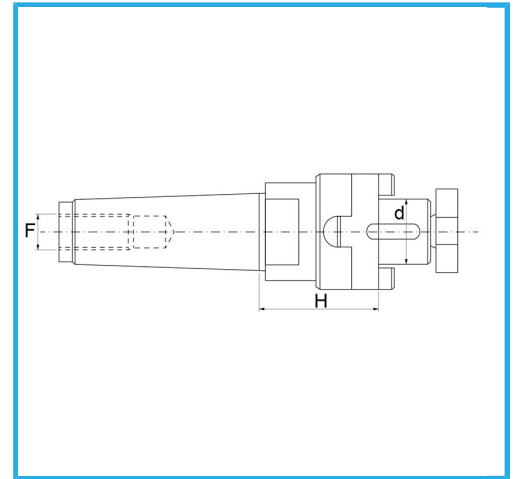

€102,00



d - h6	16 mm
Cono morse	CM 3
F	M 12
H	40 mm
Dimensioni imballo	190x55x55 h mm
Peso lordo	0,66 kg
Codice EAN	8012667179601



Scatola



Rettificato



18Ni
CrMo5