

DIN 228/A PER FRESE CILINDRICHE FRONTALI SECONDO NORMA DIN 481, PER FRESE CON SCANALATURA LONGITUDINALE DIN 1880 E PER FRESE AD...

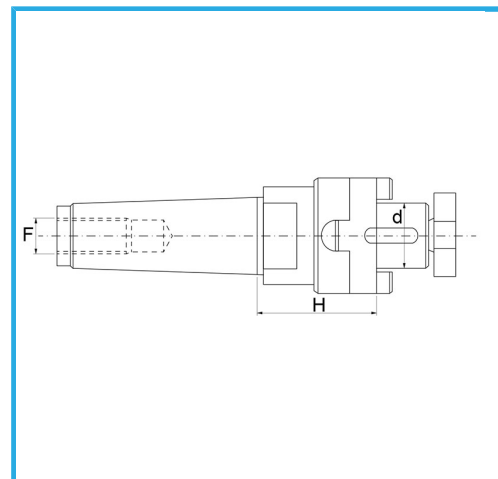

€102,00



d - h6	27 mm
Cono morse	CM 3
F	M 12
H	50 mm
Dimensioni imballo	230x70x70 h mm
Peso lordo	1,27 kg
Codice EAN	8012667179625



Scatola



Rettificato

18Ni
CrMo5