

€30,70

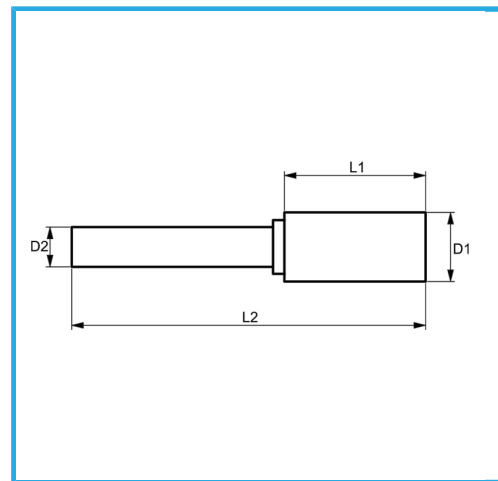

D1	Ø 12 mm
L1	25 mm
D2	6 mm
L2	70 mm
Dimensioni imballo	17 x 95 x 17 h mm
Peso lordo	0,06 kg
Codice EAN	8012667356446

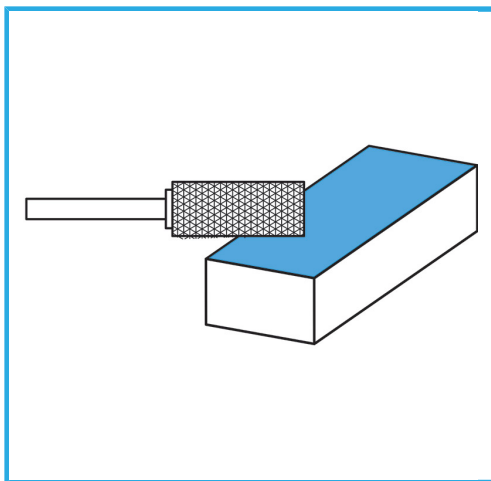

Scatola



HM