

PER L'ESECUZIONE DI FORI DI MEDIE E GRANDI DIMENSIONI NEL MURO.

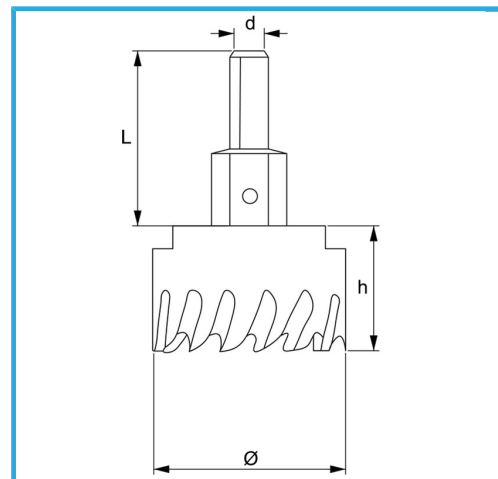

€28,60



Ø	40 mm
d	10 mm
Filetto	M12 x 1,25
Z	5
L	46 mm
Punta	Ø 6 x 69 mm
Peso lordo	0,23 kg
Dimensioni imballo	60x60x110 h mm
Codice EAN	8012667352646



Append.

HSS

HM