

PER L'ESECUZIONE DI FORI DI MEDIE E GRANDI DIMENSIONI NEL MURO.

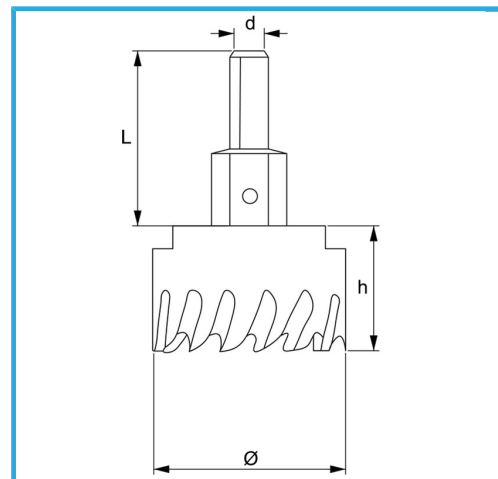

€36,60



Ø	55 mm
d	12 mm
Filetto	M16 x 1,5
Z	6
L	46 mm
Punta	Ø 8 x 69 mm
Peso lordo	0,32 kg
Dimensioni imballo	60x60x110 h mm
Codice EAN	8012667352677



Append.

HSS

HM