

DIN 2080, CORPO MANDRINO BILANCIATO. EQUILIBRATURA 2.000 RPM.

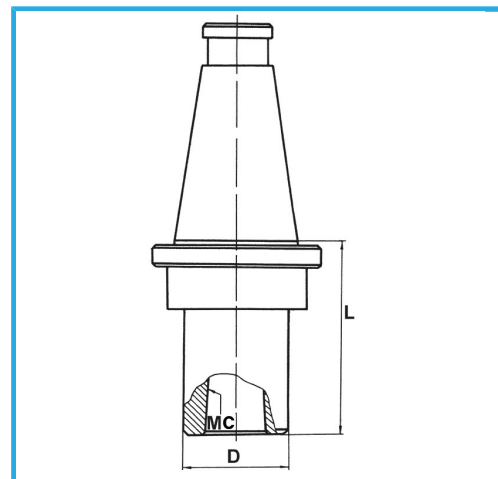

€127,00



ISO	40
CM	1
D	25 mm
L	15 mm
Peso lordo	0,92 kg
Dimensioni imballo	-
Codice EAN	8012667008208



Scatola



Rettificato

18Ni
CrMo5

-