

DIN 228/A, PER IL MONTAGGIO DI UTENSILI CON GAMBO CILINDRICO SU PINZE DIN 6499 (ER). FORNITO CON GHIERA DI SERRAGGIO.

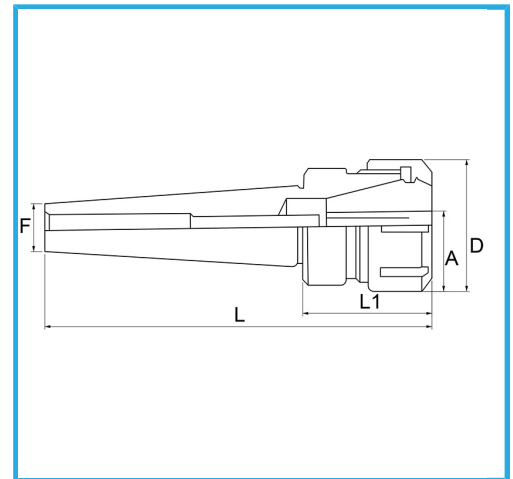

€108,00



Pinze	ER 32
D	50 mm
L	166 mm
L1	58 mm
F	M 16
A	3/20 mm
Peso lordo	0,84 kg
Dimensioni imballo	56x56x170 h mm
Codice EAN	8012667187569



Scatola

18Ni
CrMo5



Rettificato