

ISO 2.

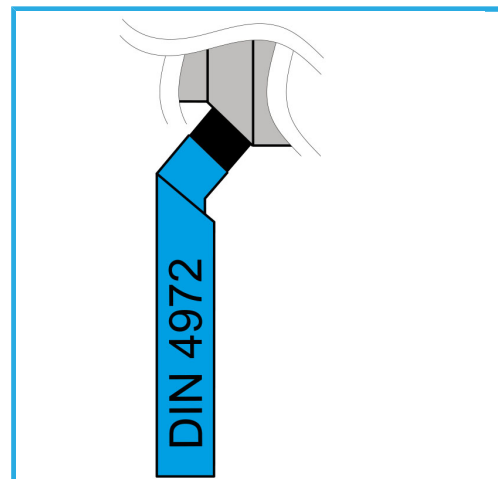

€7,20

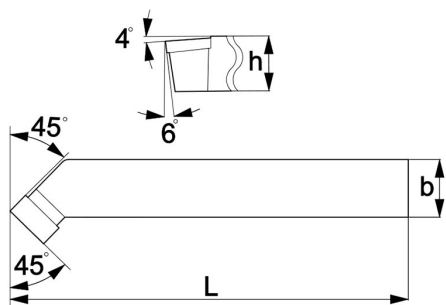

Lato	Dx/R
L	100 mm
b	12 mm
h	12 mm
Dimensioni imballo	135x40x40 h mm
Peso lordo	0,11 kg
Codice EAN	8012667007485

HM
P25



4972