

DIN 228/A PER FRESE CILINDRICHE FRONTALI SECONDO NORMA DIN 481, PER FRESE CON SCANALATURA LONGITUDINALE DIN 1880 E PER FRESE AD...

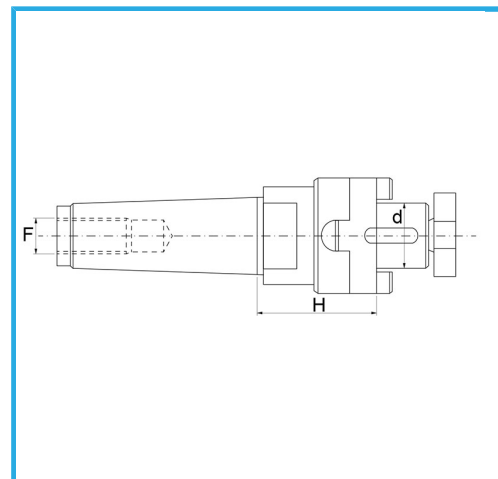

€102,00



d - h6	22 mm
Cono morse	CM 3
F	M 12
H	50 mm
Dimensioni imballo	55x55x170 h mm
Peso lordo	0,72 kg
Codice EAN	8012667179618



Scatola



Rettificato

18Ni
CrMo5