

PER L'ESECUZIONE DI FORI DI MEDIE E GRANDI DIMENSIONI NEL MURO.

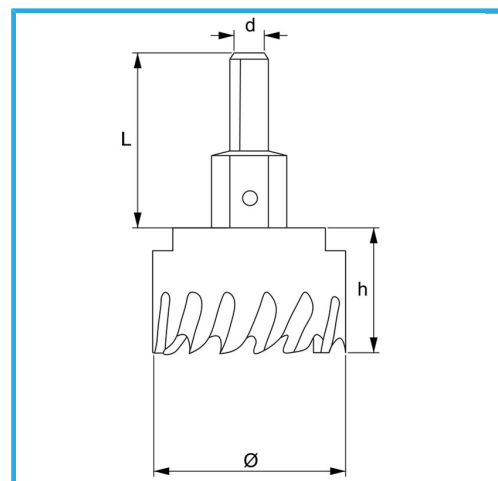

€81,90



Ø	95 mm
d	12 mm
Filetto	M16 x 1,5
Z	10
L	46 mm
Punta	Ø 8 x 69 mm
Peso lordo	0,68 kg
Dimensioni imballo	105x40x130 h mm
Codice EAN	8012667352745



Append.

HSS

HM