

PER L'ESECUZIONE DI FORI DI MEDIE E GRANDI DIMENSIONI NEL MURO.

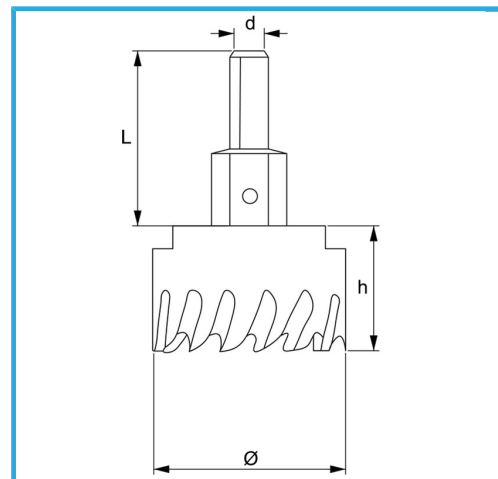

€38,90



Ø	60 mm
d	12 mm
Filetto	M16 x 1,5
Z	7
L	46 mm
Punta	Ø 8 x 69 mm
Peso lordo	0,38 kg
Dimensioni imballo	75x75x130 h mm
Codice EAN	8012667352684



Append.

HSS

HM