

MAS-403 BT, CORPO MANDRINO BILANCIATO. EQUILIBRATURA 12.000 RPM.

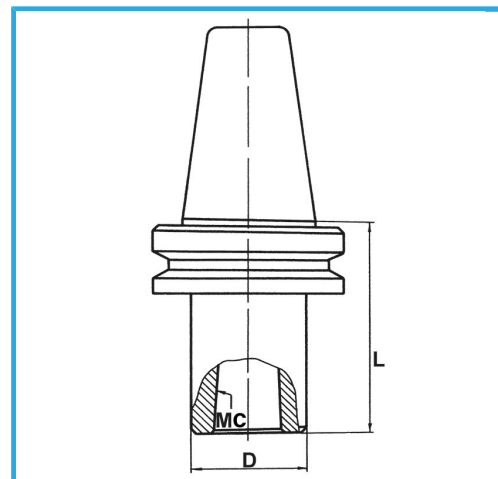

€133,00



BT	40
CM	4
D	50 mm
L	98 mm
Peso lordo	1,59 kg
Codice EAN	8012667008482



Scatola



Rettificato

18Ni  
CrMo5