

DIN 2080, CORPO MANDRINO BILANCIATO, PER FRESE (WELDON)
SECONDO NORMA DIN 1835 B E DIN 6535 HB. FORNITO CON VITE DI
SERRAGGIO....

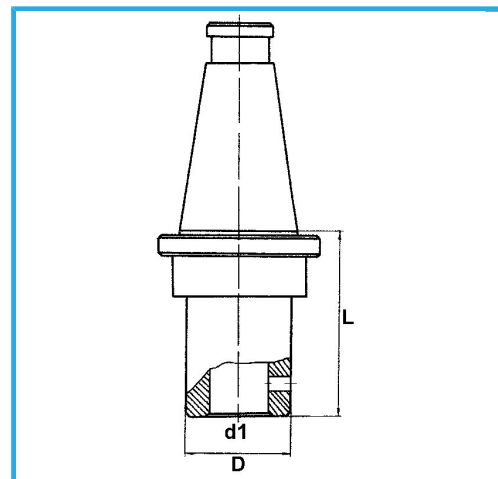

€154,00



ISO	50
d1 - h6	25 mm
D	65 mm
L	80 mm
Peso lordo	4,76 kg
Codice EAN	8012667187583



Scatola



Rettificato

18Ni
CrMo5