

ER32 DIN 6499/B UTILIZZABILE CON MANDRINI PORTAPINZE.

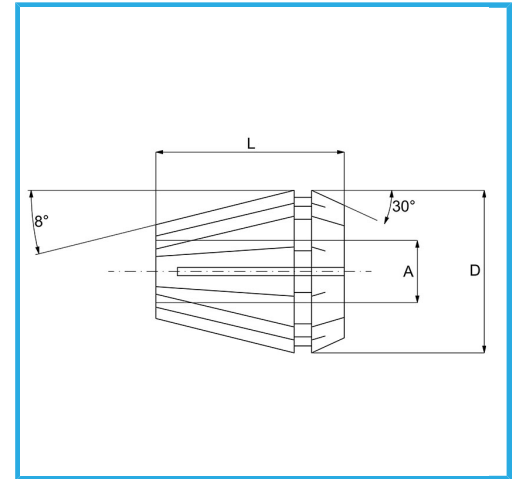

€15,70



Capacità A	11-12 mm
D	33 mm
L	40 mm
Tolleranza	$\pm 0,015 \text{ mm}$
Dimensioni imballo	40x40x45 h mm
Peso lordo	0,14 kg
Codice EAN	8012667141998



Scatola



Rettificato

65Mn