

MAS-403 BT, CORPO MANDRINO BILANCIATO. EQUILIBRATURA 12.000 RPM.

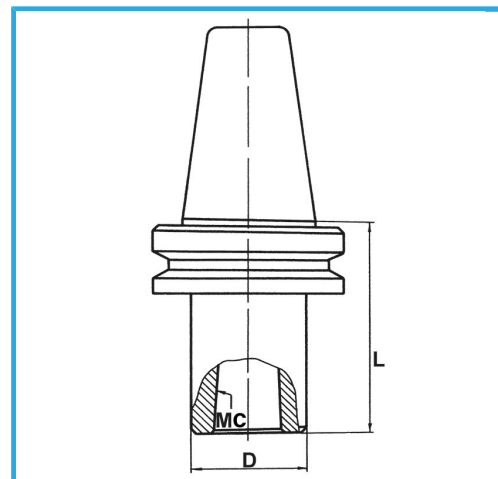

€127,00



BT	40
CM	3
D	40 mm
L	75 mm
Peso lordo	1,38 kg
Codice EAN	8012667008475



Scatola



Rettificato

18Ni  
CrMo5