

ER32 DIN 6499/B UTILIZZABILE CON MANDRINI PORTAPINZE.

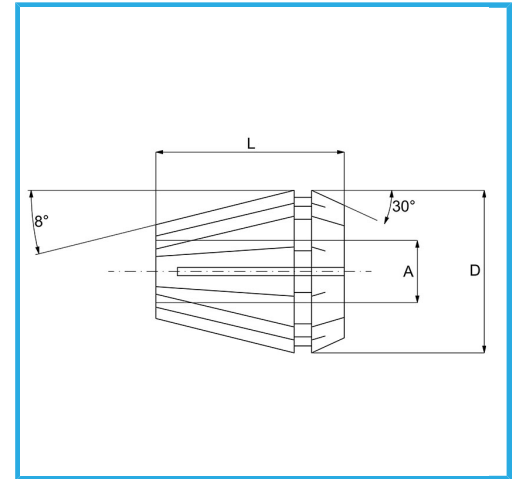

€15,70



| | |
|--------------------|------------------------|
| Capacità A | 8-9 mm |
| D | 33 mm |
| L | 40 mm |
| Tolleranza | $\pm 0,015 \text{ mm}$ |
| Dimensioni imballo | 46x46x45h mm |
| Peso lordo | 0,20 kg |
| Codice EAN | 8012667141967 |



Scatola



Rettificato

65Mn