

DIN 2080, CORPO MANDRINO BILANCIATO, PER FRESE (WELDON)
SECONDO NORMA DIN 1835 B E DIN 6535 HB. FORNITO CON VITE DI
SERRAGGIO....

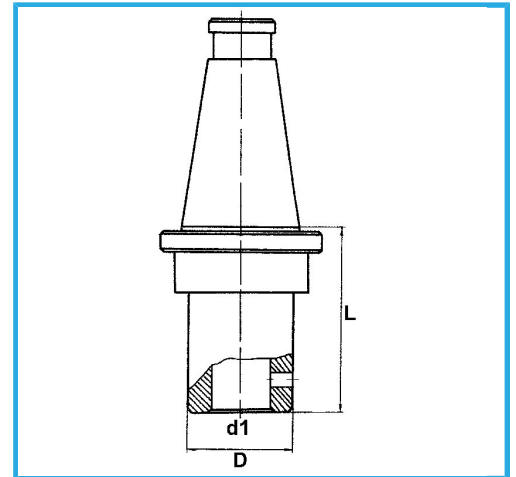

€154,00



ISO	50
d1 - h6	20 mm
D	52 mm
L	63 mm
Peso lordo	2,00 kg
Codice EAN	8012667195465



Scatola



Rettificato



18Ni
CrMo5