

PER L'ESECUZIONE DI FORI DI MEDIE E GRANDI DIMENSIONI NEL MURO.

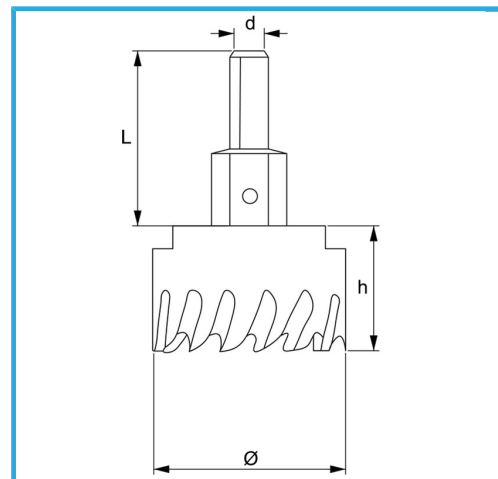

€22,70



Ø	30 mm
d	10 mm
Filetto	M12 x 1,25
Z	4
L	46 mm
Punta	Ø 6 x 69 mm
Peso lordo	0,15 kg
Dimensioni imballo	40x40x120 h mm
Codice EAN	8012667352615



Append.

HSS

HM