

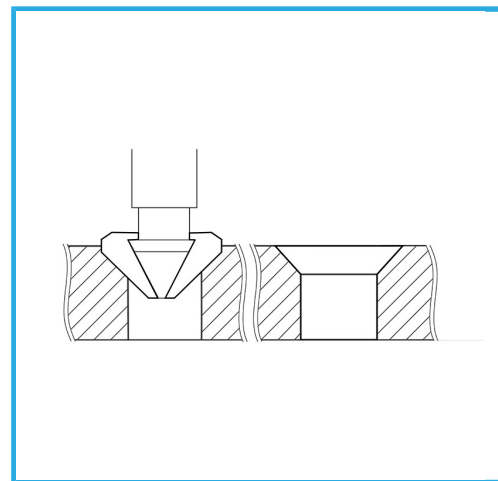







CON SPOGLIE RETTIFICATE E SCANALATURE RICAVATE DAL PIENO,
PER ESEGUIRE SVASATURE CONICHE SENZA VIBRAZIONI.



€97,80



Ø max 6 - 8 - 10 - 12,4 - 16,5 - 20,5 mm
Peso lordo 0,48 kg
Dimensioni imballo 145x105x45 h mm
Codice EAN 8012667183257

	Append.		90°
	Esterna		6 Pcs
	335C		HSS -
	TIN		-