

DIN 2080, CORPO MANDRINO BILANCIATO, PER FRESE (WELDON)
SECONDO NORMA DIN 1835 B E DIN 6535 HB. FORNITO CON VITE DI
SERRAGGIO....

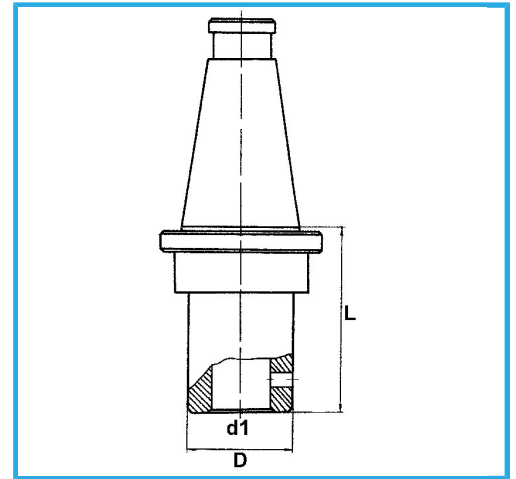

€154,00



ISO	50
d1 - h6	32 mm
D	72 mm
L	80 mm
Peso lordo	4,16 kg
Codice EAN	8012667187606



Scatola



Rettificato

18Ni
CrMo5