

DIN 2080, CORPO MANDRINO BILANCIATO, PER FRESE (WELDON)
SECONDO NORMA DIN 1835 B E DIN 6535 HB. FORNITO CON VITE DI
SERRAGGIO....

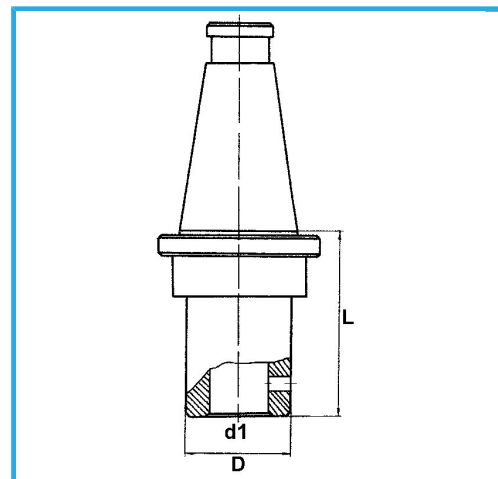

€129,00



| | |
|------------|---------------|
| ISO | 40 |
| d1 - h6 | 12 mm |
| D | 42 mm |
| L | 50 mm |
| Peso lordo | 1,14 kg |
| Codice EAN | 8012667195922 |



Scatola



Rettificato

18Ni
CrMo5