

DIN 2080, CORPO MANDRINO BILANCIATO. EQUILIBRATURA 2.000 RPM.

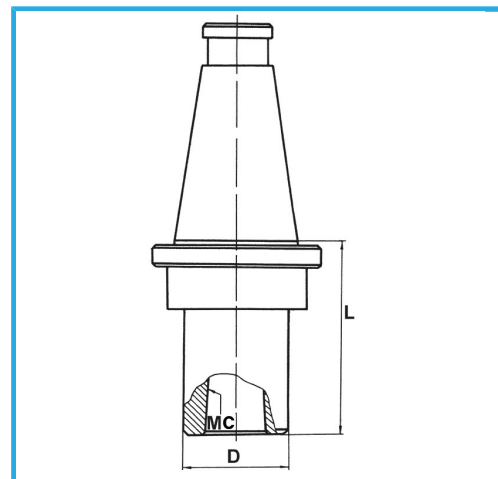

€171,00



ISO	50
CM	3
D	40 mm
L	30 mm
Peso lordo	3,12 kg
Dimensioni imballo	-
Codice EAN	8012667008253



Scatola



Rettificato

18Ni
CrMo5

-